

Product Information

Fiber optic panel BKT VENI-2-LIGHT

Card No.: PI_FO_panel_BKT_VENI-2-LIGHT_11112LXXXX.XV_01.23



* Exemplary configuration

Application

The series of VENI-2 fibre optic products is designed for the most demanding customers. The increased functionality of the panels combines state-of-the-art design with quality manufacturing materials.

The VENI-2 fibre optic panel is an essential connectivity component in all networks when proper protection of transmission infrastructure is of great importance. It is intended for quick crossing of connections between distribution points. The perfectly arranged base of the panel, in combination with a wide range of additional accessories, makes this the perfect solution for Data Center systems and wherever connection of optical fibres under difficult installation conditions is required.

As a total solution our VENI-2 fiber optic panels are also available fully equipped with pigtails, adapters and splice trays. This fully loaded version dramatically reduces installation time in new or existing telecommunications networks.

Features

- A universal housing and base that allows the drawer to be pulled out with or without optional telescopic ball bearing slides
- The base can be removed from the telescopic ball bearing slides before installation
- Adjustable handles 19" with a possibility of assembly on the front or back of the panel
- Raised slots in base for mounting cables and tubes with different outer diameters
- Integrated front plates 24xSC simplex/LC duplex or 24xSC duplex/LC quad
- Integrated front plates prepared for lock assembly
- Two pull-out possibilities for the drawer: horizontal and diagonal
- Holes in the base for one- or two-point assembly of splice tray
- Front plates equipped with metal captive screws
- Six rear cable entries
- FRP rod termination point
- Optional patch cord organizer
- Colour: black or grey

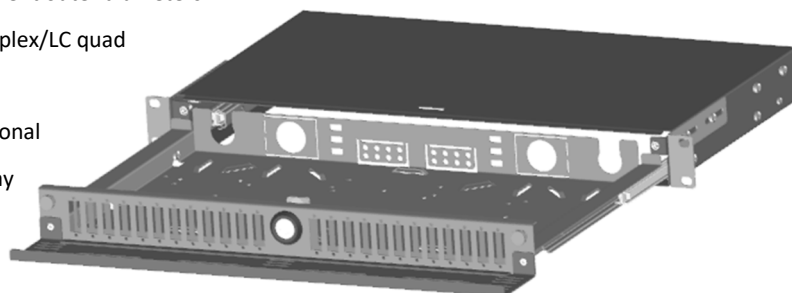

Meet VENI-2 family

Features/ Model	VENI-2-TOP	VENI-2-LIGHT	VENI-2-DATA
Sliding base	Yes	Yes	No
Front plates	Removable	Integrated with base	Removable
Size	1U, 2U	1U	1U

Product Information

Fiber optic panel BKT VENI-2-LIGHT

Card No.: PI_FO_panel_BKT_VENI-2-LIGHT_11112LXXXX.XV_01.23

Features

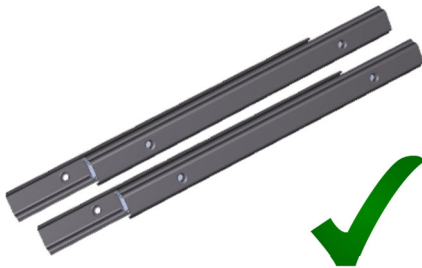

Metal Captive Screw

A universal housing and base that allows the drawer to be pulled out with or without optional telescopic ball bearing slides

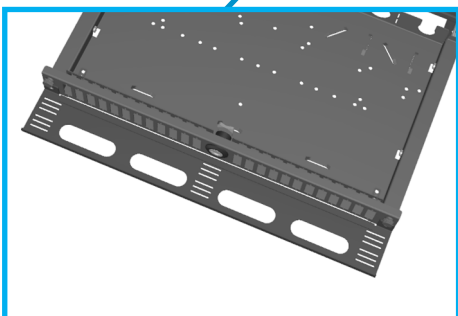
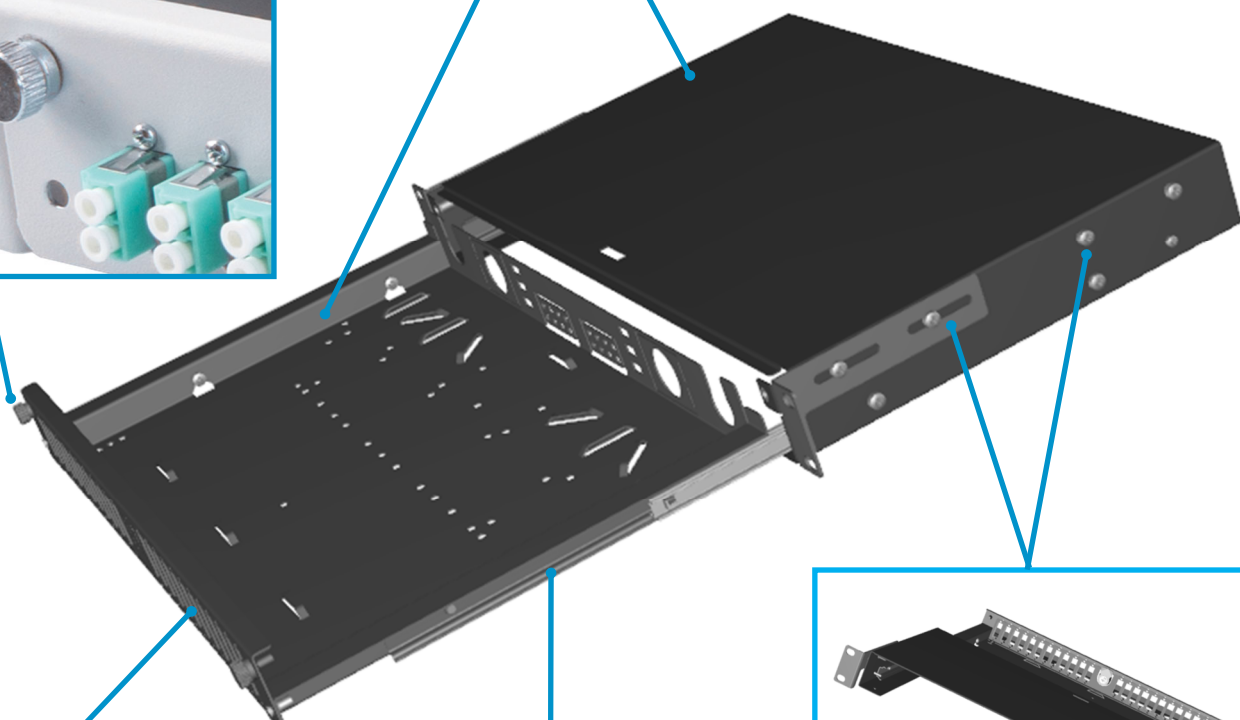
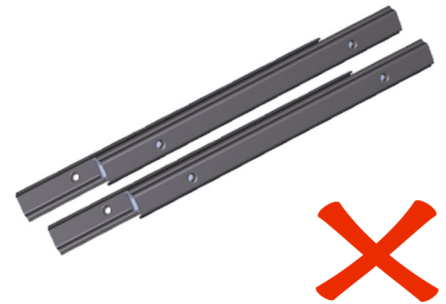

Integrated cable organizer (OPTION)

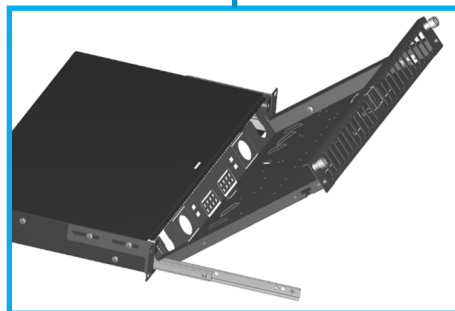

The base can be removed from the ball bearing slides before installation

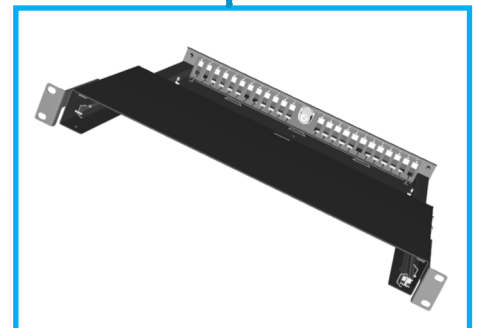

Front- or rear-mountable 19" adjustable mounting lugs

Product Information

Fiber optic panel BKT VENI-2-LIGHT

Card No.: PI_FO_panel_BKT_VENI-2-LIGHT_11112LXXXX.XV_01.23

Features

90° and 45° raised slots for cable and pigtails assembly



Holes for leaf type splice trays mounting plate



FRP rod termination points (OPTION)

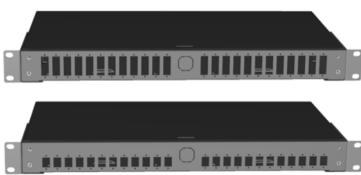
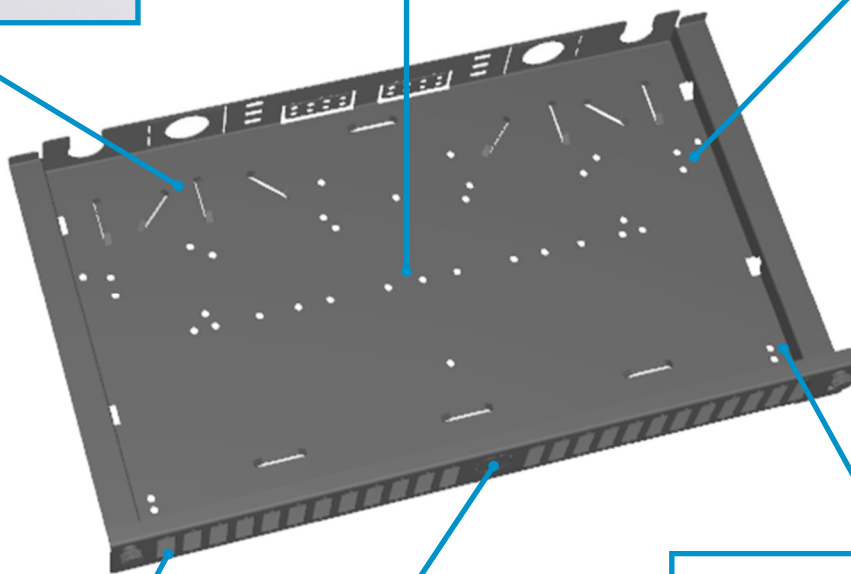
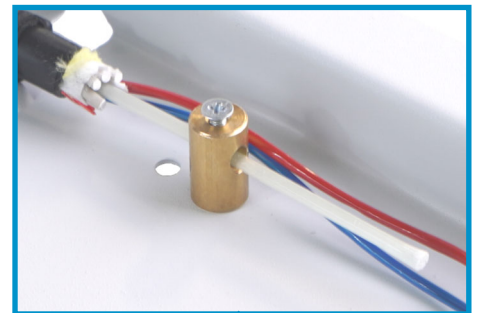

Integrated front plates



Most of the front plates have an opening for lock (OPTION)

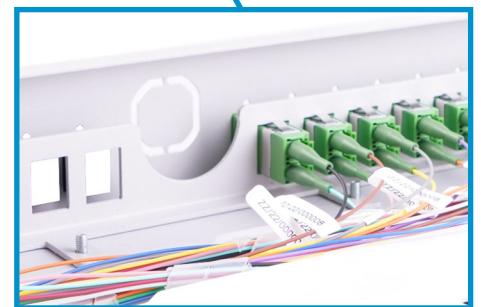

Optional plate for screwless mounting of fibre optic adapters (OPTION)

Product Information

Fiber optic panel BKT VENI-2-LIGHT

Card No.: PI_FO_panel_BKT_VENI-2-LIGHT_11112LXXXX.XV_01.23

Features

PG13.5/16/M20 closed cable entries
(for multifiber cables)

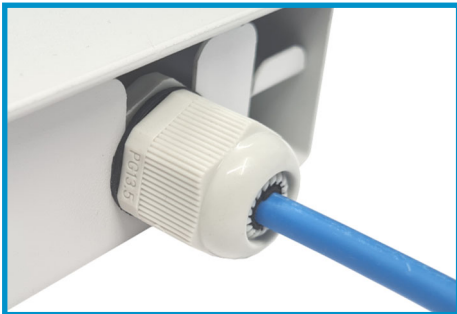

Possibility to mount cable along the
rear of the panel



PG13.5/16/M20 cable entries with
the function of angle adjustment

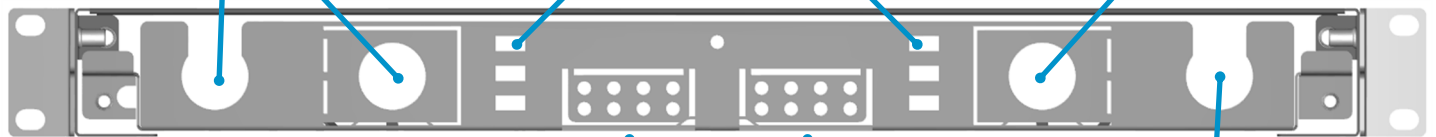
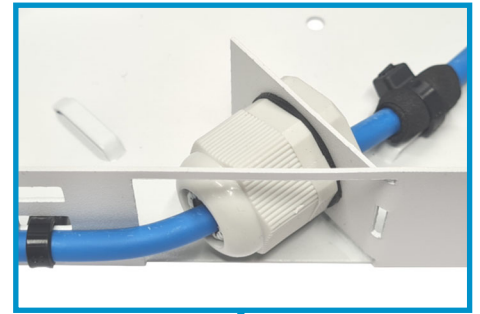

Threaded pin with knurled nut
mounted to base for traditional
fiber optic splice trays and mounting
screws and nuts included in each set

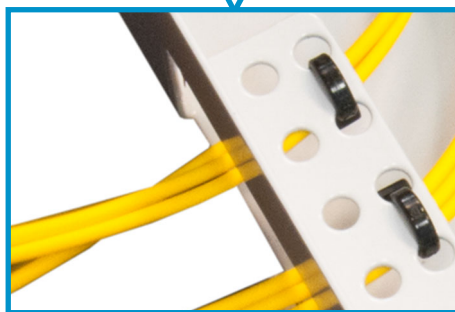

Swing-up entry points for fixing
cables with small diameters



PG13.5/16/M20 cable entries
for cables Ready2Use

Product Information

Fiber optic panel BKT VENI-2-LIGHT

Card No.: PI_FO_panel_BKT_VENI-2-LIGHT_11112LXXXX.XV_01.23

Technical data

Height (U)	Height (mm)	Width (mm)	Depth (mm)	Weight (kg)	Colour grey RAL 7035	Colour black RAL 9005
1U	42	443	241	2,4	√	√

Performance / Variants

Index		Product description
Colour grey	Colour black	
11112L2241.1V	11112L2241.3V	Fiber optic panel BKT VENI-2-LIGHT, 19", 1U, sliding, 24xSC simplex/LC duplex
11112L1241.1V	11112L1241.3V	Fiber optic panel BKT VENI-2-LIGHT, 19", 1U, sliding, 24xSC duplex/LC quad
23.XXX*	23.XXX*	Fiber optic panel BKT VENI-2-LIGHT, 19", XU, sliding, equipped

*Index depends from chosen configuration

Accessories

Index		Product description
Colour grey	Colour black	
111A0001.1V	111A0001.3V	Cable organizer BKT VENI-2, mounting from the front of the panel
111A2241.1V	111A2241.3V	Screwless adapters plate BKT VENI-2, 1U, 24xSC simplex/LC duplex
111A1241.1V	111A1241.3V	Screwless adapters plate BKT VENI-2, 1U, 24xSC duplex/LC quad

Index	Product description
11112000	Telescopic ball bearing slides VENI-2 (2pcs)
10500150	Mounting bracket to FRP rod, brass, Φ 10mm/M3(female)x17mm
10500160	Cam lock to fiber optic panel VENI-2, with key 1333 (2pcs)
105SM2265B.100	Self tapping screw (SMS) M2.2x6.5mm, pan head, PH1, ISO7049, DIN7981C (100pcs)
11320030.3	Fiber optic splice tray BKT Classic-2, 155x92x8mm, 2 holders x12 splice protector 2.4-2.5mm diam./45-35mm lgth, white
11320351	Heat shrink splice protection sleeve, 45mm length, 2.4mm outside diameter after shrink (100pcs)
11320353	Heat shrink splice protection sleeve, 45mm length, 2.5mm outside diameter after shrink (50pcs)
11320028.2	Fiber optic splice tray BKT Classic, 155x92x8mm, 2 holders x6 ANT type splice protector 1.2mm width/45-20mm lgth, black
10490050	Aluminium splice protection sleeve ANT type, 30mm length, 1.2mm width
10490012.10	Blind cover SCsx to front plate/fiber optic panel, black (10pcs)
10490013.10	Blind cover SCdx to front plate/fiber optic panel, black (10pcs)
10490011	Blind cover FC/ST to front plate/fiber optic panel, black
10490020	Cable gland PG13.5 with locknut, poliamid, grey
11320050	Cable gland PG16 with locknut, poliamid, grey

Product Information

Fiber optic panel BKT VENI-2-LIGHT

Card No.: PI_FO_panel_BKT_VENI-2-LIGHT_11112LXXXX.XV_01.23

Accessories

Index	Service accessories
10500098	Threaded pin M5(male)/M3(female)x36mm, for panel VENI-2/1U
10530062	Knurled nut M5x16x6mm, nylon, BN5934, to threaded pin for panel VENI-2
10530061	Knurled screw M4x17.5, mounting from the front of the panel VENI-2
105SMBN833	Safety ring for knurled screw M4x17.5, for panel VENI-2 (100 pcs.)
105SM3080S	Countersunk flat head screw M3x8mm, PH1, DIN965A (200pcs)
105SM3000S	Hexagon flange nut M3x8x4mm, DIN6953, EN1661 (100pcs)