

Product Information

BKT cable coupler cat.6_A, AWG 22-23, shielded, toolless

Card No.: PI_11331013_01.19



Application

The BKT cable coupler cat 6_A cable connector allows to twisted pair cable connections with 22-23 AWG wire diameter. It is used with in the event of a line failure or in case of extension of the line due to the shift of the ending point. The transmission path in which the coupler is used is not a subject to certification. **The minimum distance of the coupler from outlet is 2m.**

Features

- IDC slot connection for cables with 22-23 AWG
- Color-coded organiser according to T568A and T568B schemes
- Toolless and easy termination
- Conforms with requirements of RoHS
- Dimensions (W x H x D) – 11,58 mm x 59,73 mm x 14,51 mm

Standards

- EN 50173-1
- EN 60603-7-51
- ISO/IEC 11801
- IEC 60603-7-51
- ANSI/TIA-568B.2-10
- RoHS 2011/65/EU

Product Information

BKT cable coupler cat.6_A, AWG 22-23, shielded, toolless

Card No.: PI_11331013_01.19

Special features

Universal IDC slot connection for wires with 22-23 AWG

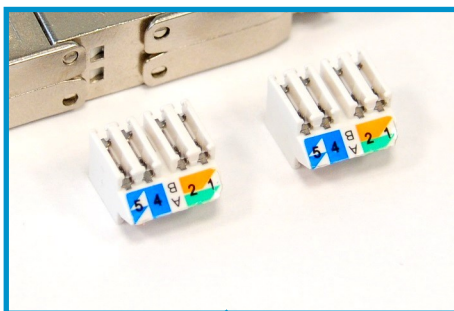

Color-coded scheme on the organiser that facilitates termination

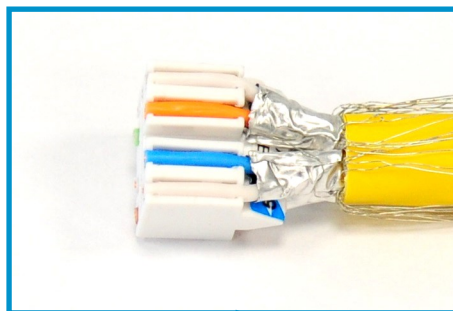

Toolless termination by closing the housing

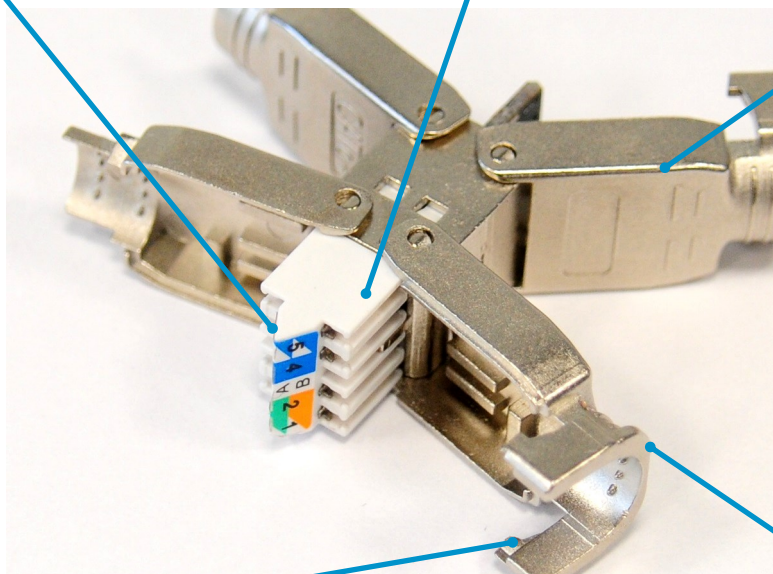
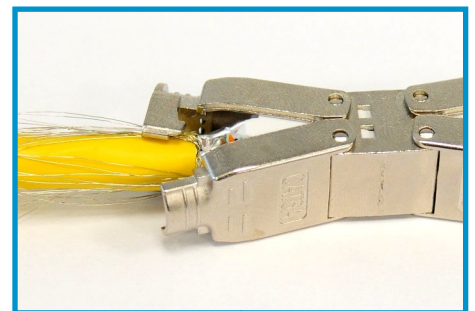

Dimensions
14,51 mm x 59,73mm x 11,58mm

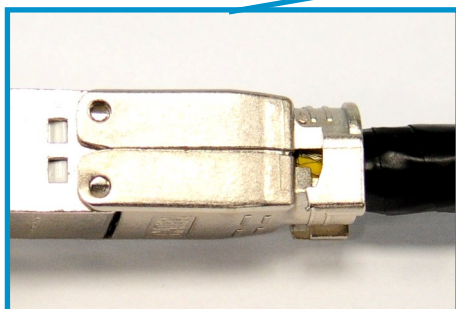

Securing latch against opening

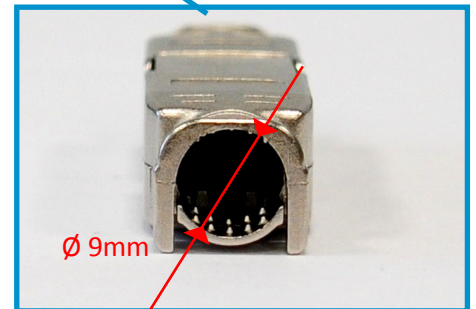

Suitable for the cables up to 9mm
OD

Product Information

BKT cable coupler cat.6_A, AWG 22-23, shielded, toolless

Card No.: PI_11331013_01.19

Physical and electrical properties

Insulation resistance [MΩ]	≤ 500 at 100VDC
Dielectric withstanding voltage	DC 1000V, AC 700V AC RMS 60Hz during 60s
Termination resistance [mΩ]	20
Durability	250 cycles
Contact blade	Nikel plated phosphor bronze
Wire diameter [AWG]	22 - 23
Housing	Zink alloy
Organiser	PC

Dimensions [mm]

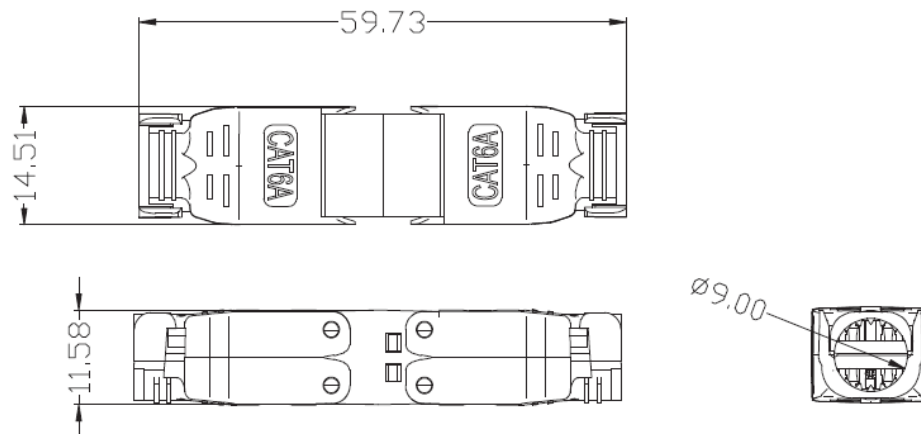

Performance / Variants

Index	Product description
11331013	BKT cable coupler cat.6 _A , AWG 22-23, shielded, toolless