

Product Information

BKT RJ45 cat.6 Keystone module, unshielded, toolless

Card No.: PI_11332011_01.21



Application

The BKT RJ45 module is used to build a four-pair copper transmission link and, more specifically, to terminate the link with an RJ45 connector in the form of a socket. The compact BKT RJ45 module, in the universal and popular "keystone" mounting standard, can be used in a wide range of electrical installation equipment used in telecommunications subscriber sockets and enables installation in modular patch panels at distribution points such as IT cabinets. The performance of the solution is confirmed by laboratory testing and a set of design features ensures repeatability and high quality of teletechnical installations.

Features

- Information about the category on the front of the module
- Each keystone module includes id tag
- Each keystone module includes dust cover of the port which protects pins against both dust and mechanical damage
- The system of colored id tags/dust covers allows to divide network identification according to the preferences of the user or administrator
- A unique mounting system enabling cable entry from the side or traditionally at the back of the module
- The "keystone" standard of the module guarantees compatibility with a wide range of electro-installation accessories
- The cable insertion from the back of the module doesn't need use of cable tie
- Universal IDC slot connection for solid and stranded wires with 22-26 AWG
- Integrated short circuit protection of conductors
- T568A/B scheme indicated on the tool free organizer and inside the module
- Color of the keystone mounting latch in accordance with the BKT cabling system performance naming: red = cat. 6A, blue = cat. 6, grey = cat. 5e
- Logo on the "keystone" body to help identify the system manufacturer
- Coherent design of shielded and unshielded module from cat. 8.1 to cat. 5e
- Standards compliance confirmed by tests carried out in independent laboratories
- Certified compliance with PoE standard (PoE, PoE+, 4PPoE)
- 25 years system guarantee
- Compact dimensions (H x W x D) – 20,4 mm x 17 mm x 37,4 mm
- 3 assembly methods:
 - 1.Toolless: no special assembly tools needed
 - 2.Tool: using 110 IDC impact tool
 - 3.Tool: using BKT HAT automatic tool

Standards

- EN 50173-1
- EN 60603-7-4
- ISO/IEC 11801
- IEC 60603-7-4
- IEC 60512-99-002
- IEEE 802.3af/at/bt
- ANSI/TIA-568.2
- RoHS 2011/65/EU



Product Information

BKT RJ45 cat.6 Keystone module, unshielded, toolless

Card No.: PI_11332011_01.21

Special features

The cable insertion from the back of the module doesn't need use of cable tie

Standards compliance including PoE, PoE +, 4PPoE, confirmed by tests carried out in independent laboratories

Color of the keystone mounting latch in accordance with the BKT cabling system performance naming

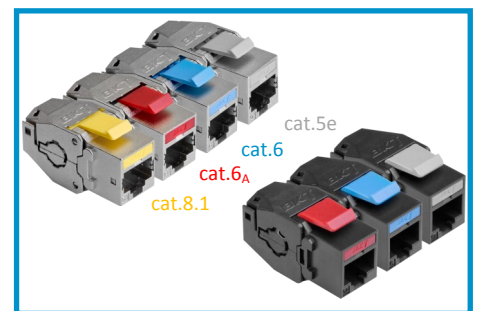
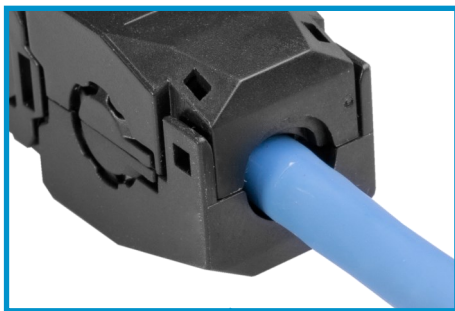

Side clamp (index 1133A230) guarantees secure cable fastening

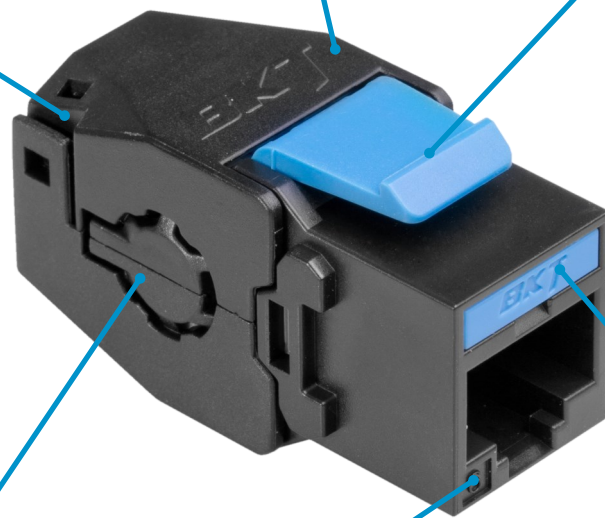
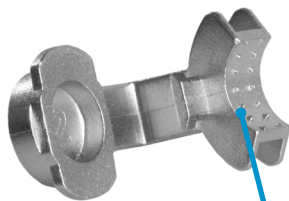

Coherent design of shielded and unshielded module from cat. 8.1 to cat. 5e

Compact dimensions [mm]

20,4 x 17 x 37,4



A unique mounting system enabling cable entry from the side of the module

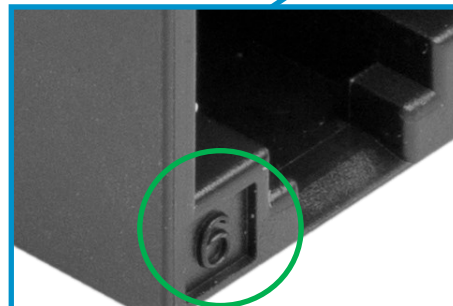

Information about the category on the front of the module



8 colors

The system of colored id tags/dust covers allows to divide network & identification according to the preferences of the user or administrator

Product Information

BKT RJ45 cat.6 Keystone module, unshielded, toolless

Card No.: PI_11332011_01.21

Special features

T568A/B scheme indicated on the toolless organiser and inside the module

Universal IDC slot connection for wires with 22-26 AWG

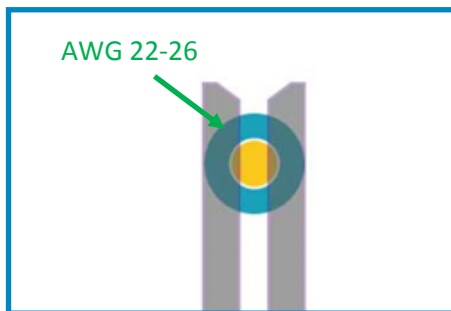
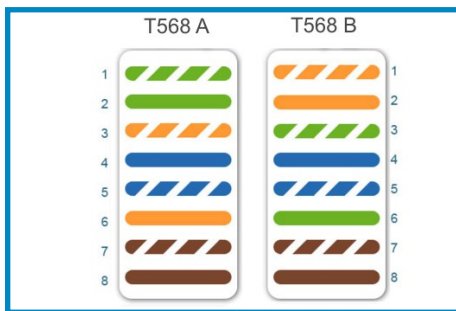

Toolless organiser

Tool organiser

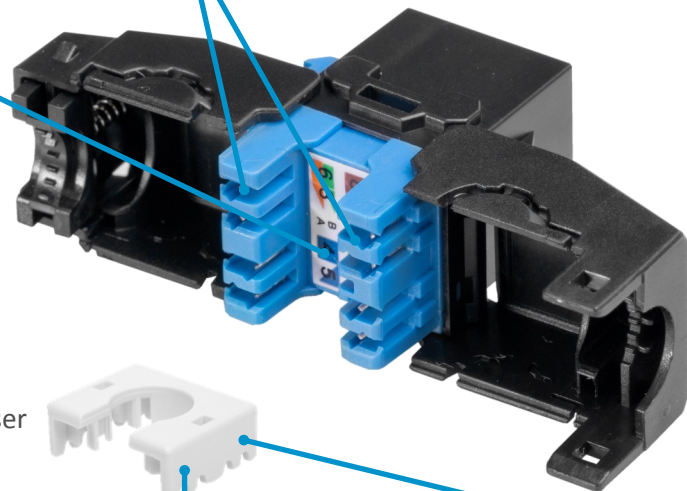

1. assembly method

Toolless: no special assembly tools needed



2. assembly method

Tool: using 110 IDC impact tool



3. assembly method

Tool: using BKT HAT automatic tool

Product Information

BKT RJ45 cat.6 Keystone module, unshielded, toolless

Card No.: PI_11332011_01.21

Physical and mechanical properties

Performance	<ul style="list-style-type: none"> - T568A & T568B wiring map printing in toolless organiser and IDC slot - Insertion force: 20N max - Retention strenght: 7,7 kg between jack and plug - Operation temperature: -20°C to 60°C
Durability	<ul style="list-style-type: none"> - Jack: ≥ 750 cycles plug-jack mating and unmating test, insertion cycles at 20 cycles/minute max., contact resistance test per 100 cycles - IDC: ≥ 20 terminations for 22-26 AWG stranded and solid wire, compatible with 110 tool and BKT HAT tool
RJ45 Jack	<ul style="list-style-type: none"> - Housing: ABS + PC, UL 94-V0 - Contact bracket: PC, UL 94-V2
RJ45 jack contact	<ul style="list-style-type: none"> - Material: Phosphor bronze Nickel plated - Finish: 50 μm gold plated on pins
IDC	<ul style="list-style-type: none"> - Housing: PC + Fiber Glass, UL 94-V2 - Cover: ABS + PC, UL 94-V0, black - Terminal: Phosphor bronze Tin plated
Organiser	PC + Fiber Glass, UL 94-V2
PCB	FR4, UL 94V-0
ID Tag	ABS + PC, UL 94V-0
Dust cover	PP, UL 94V-2

Dimensions [mm]

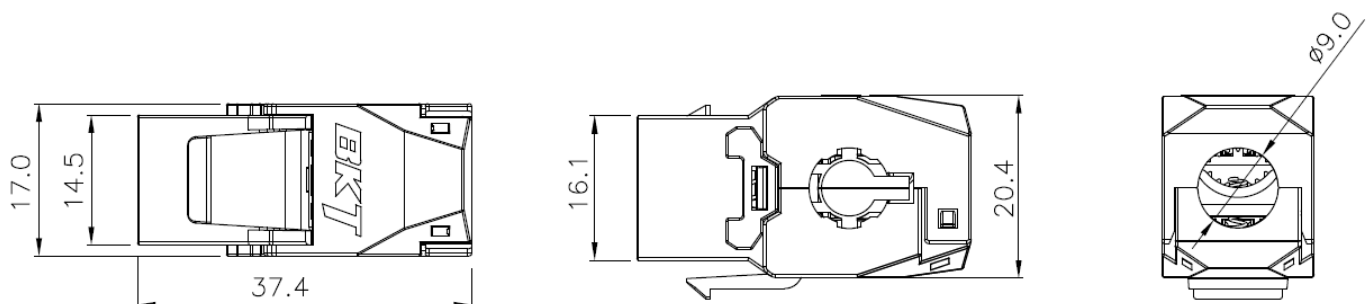

Product Information

BKT RJ45 cat.6 Keystone module, unshielded, toolless

Card No.: PI_11332011_01.21

Performance / Variants

Index	Description
11332011	BKT RJ45 cat.6 Keystone module, unshielded, toolless

Optional accessories

Index	Description
1133A111	BKT RJ45 ID Tag - white (50pcs)
1133A112	BKT RJ45 ID Tag - grey (50pcs)
1133A113	BKT RJ45 ID Tag - blue (50pcs)
1133A114	BKT RJ45 ID Tag - red (50pcs)
1133A115	BKT RJ45 ID Tag - yellow (50pcs)
1133A116	BKT RJ45 ID Tag - black (50pcs)
1133A117	BKT RJ45 ID Tag - green (50pcs)
1133A118	BKT RJ45 ID Tag - orange (50pcs)
1133A121	BKT RJ45 Dust Cover - white (50pcs)
1133A122	BKT RJ45 Dust Cover - grey (50pcs)
1133A123	BKT RJ45 Dust Cover - blue (50pcs)
1133A124	BKT RJ45 Dust Cover - red (50pcs)
1133A125	BKT RJ45 Dust Cover - yellow (50pcs)
1133A126	BKT RJ45 Dust Cover - black (50pcs)
1133A127	BKT RJ45 Dust Cover - green (50pcs)
1133A128	BKT RJ45 Dust Cover - orange (50pcs)
1133A230	BKT RJ45 Side clamp (25pcs)
11330566	Angled adaptor BKT 2xRJ45 (45 x 45) descriptive field
11330567	Angled adaptor BKT 1xRJ45 (45 x 45) descriptive field