

Product Information

BKT RJ45 cat.6_A plug, AWG 22-23, shielded, tool

Card No.: PI_11333114_01.21

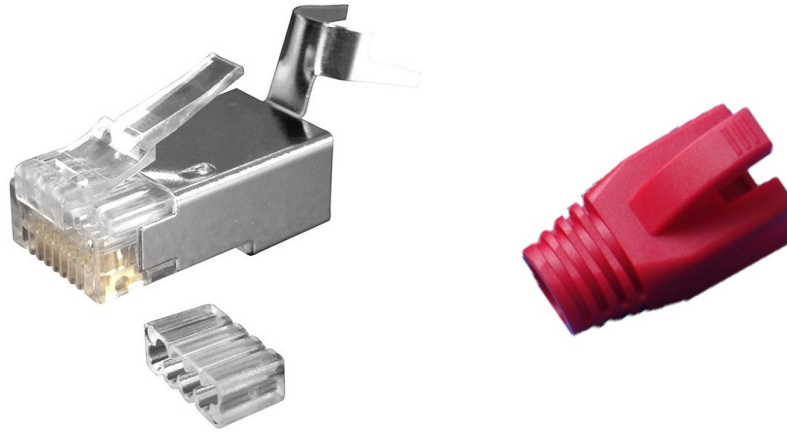

Application

BKT RJ45 plug Cat. 6_A shielded tool is a versatile and modern solution to terminate twisted pair cable with AWG 22 - 24 wire diameter. The BKT RJ45 cat. 6_A tool plug is designed to MPTL (Modular Plug Terminated Link) and E2E configuration (End to End) according to ISO/IEC TR 11801-9902:2017 standard.

Devices in MPTL and E2E configuration are mostly connected directly to the network without using patch cords e.g.:

- WiFi access points
- IP cameras
- Sensors
- Automation devices
- IoT devices at home (Internet of Things)

Features

- IDC slot connection for cables with 22-23 AWG
- Color-coded organiser according to T568A and T568B schemes
- High durability
- Boot available in red color
- Crimped by 8P/8C crimper without tongue
- Conforms with requirements of PoE +
- Conforms with requirements of RoHS
- Dimensions (W x H x D) – 7,9 mm x 11,68 mm x 21,5 mm

Standards

- EN 50173-1
- EN 60603-7
- ISO/IEC 11801
- IEC 60603-7
- IEC 60512-99-001
- ANSI/TIA-568.2
- IEEE 802.3af/at
- RoHS 2011/65/EU

Product Information

BKT RJ45 cat.6_A plug, AWG 22-23, shielded, tool

Card No.: PI_11333114_01.21

Special features

The triple pin daggers allows you to terminate the stranded and solid wire

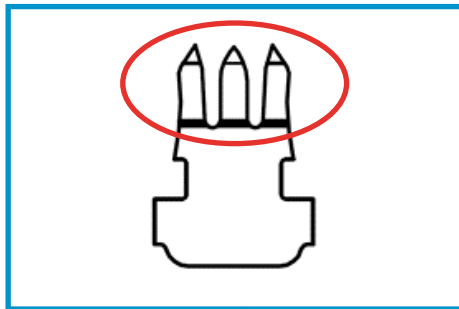

Terminating using a standard RJ45 8P crimper without a "tongue"

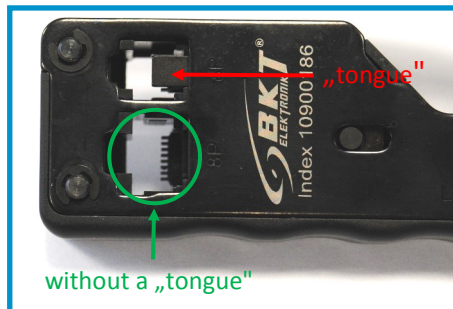

The construction element that guarantees precise shield continuity

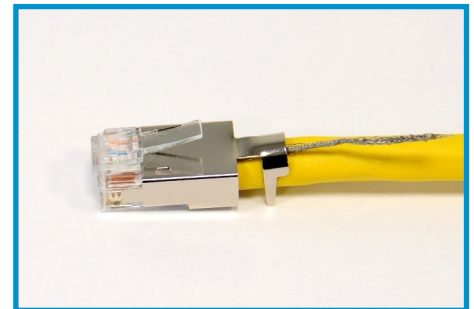

Dimensions
7,9mm x 11,68mm x 21,5mm



Can be mounted on a 22-23 AWG wires

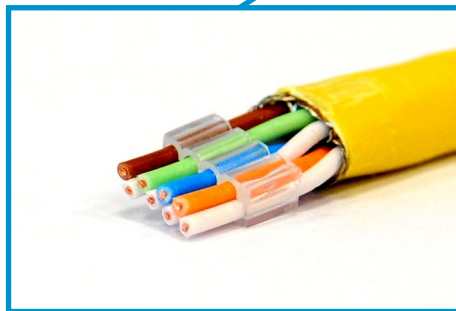
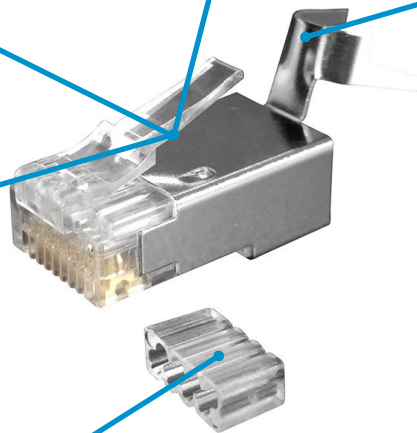

Wire divider for wires
1.35mm - 1.45mm OD



Cable boot for the cables up to 8mm OD

Product Information

BKT RJ45 cat.6_A plug, AWG 22-23, shielded, tool

Card No.: PI_11333114_01.21

Physical and electrical properties

Rated Voltage [V]	250 AC max for 2A
Rated Current [A]	2
Insulation resistance [MΩ]	100
Dielectric withstanding voltage	1000V AC RMS 50/60Hz during 60s
Termination resistance [mΩ]	<20
Durability	200 cycles
Contact blade	Gold plated copper alloy
Wire diameter [AWG]	22 - 23
Boot color	red

Dimensions [mm]

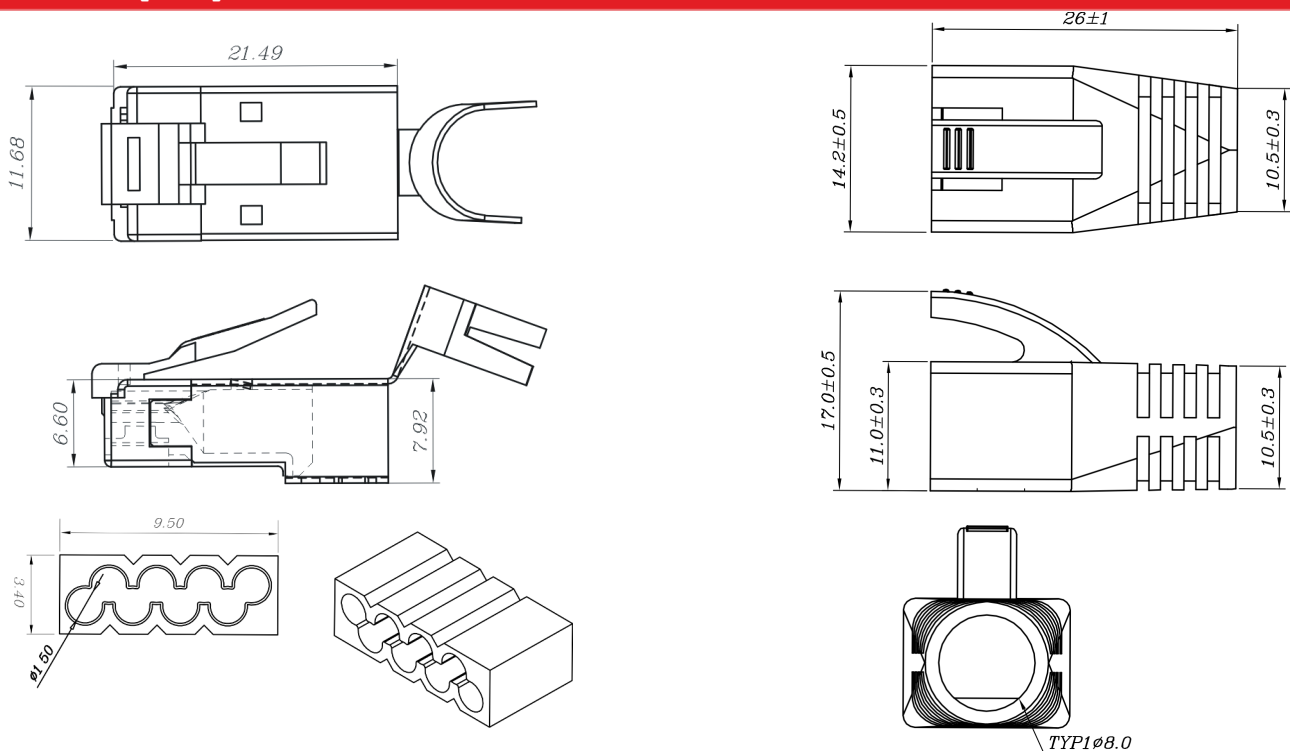

Performance / Variants

Index	Product description
11333114	BKT RJ45 cat.6A plug, AWG 22-23, shielded, tool
10900186	BKT COMPACT crimper for BKT RJ45 tool plugs