

## Product Information

BKT S/FTP cat. 6<sub>A</sub> patch cord LSHF, BKT RJ45 crimped plug

Card No.: PI\_Pcord\_BKT\_RJ45\_6A\_SFTP\_LSHF\_2145N5XX.Y\_02.24



## Application

BKT RJ45 patch cords are used for connections in distribution cabinets or for connecting devices to subscriber's outlets. They are used in server rooms, office and industrial facilities, and residential buildings. BKT patch cords are based on high quality components to ensure proper performance for a given system class.

## Features

- Plug Type: RJ45 shielded
- Connector type: 8P8C (8 Position 8 Connectors)
- Cable Form Standard: ANSI/TIA-568B
- Cable Type: S/FTP LSHF cat. 7 BKT 650L AWG 26/7
- Cable Sheath: LSHF
- 50 micron gold plated pins
- 100% copper patch cord
- BKT Logo on the plug and boot to help identify the system manufacturer
- The triple pin blades provides higher electrical conductivity
- Quality approved by independent laboratory
- Available Boot color clips as additional accessory in 7 different colors

## Standards

- EN 50173-1
- EN 61935-2
- ISO/IEC 11801
- IEC 61935-2
- ANSI/TIA-568.2
- RoHS 2011/65/EU



### Product Information

BKT S/FTP cat. 6<sub>A</sub> patch cord LSHF, BKT RJ45 crimped plug

Card No.: PI\_Pcord\_BKT\_RJ45\_6A\_SFTP\_LSHF\_2145N5XX.Y\_02.24

### Special features

Cable Standard ANSI/TIA-568B

Available color clips as additional accessory

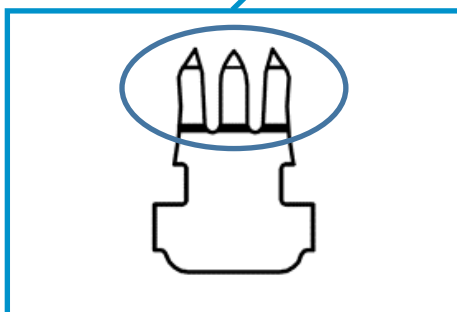
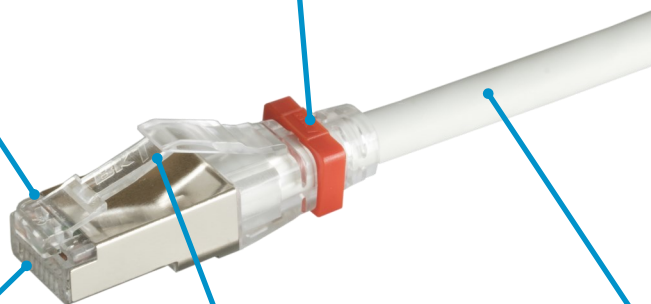
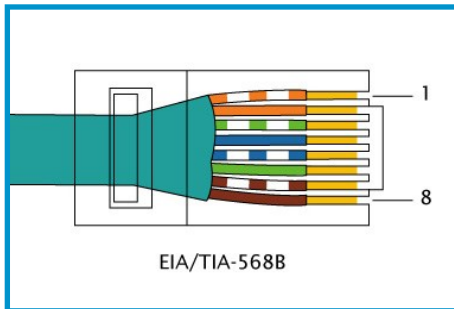

The triple pin blades provides higher electrical conductivity

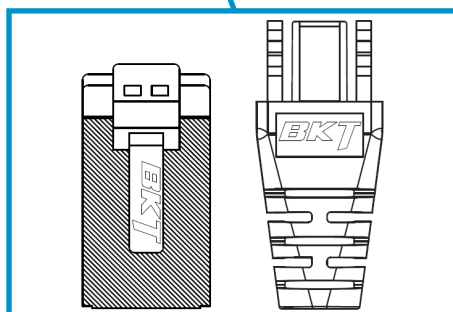

BKT Logo on the plug and boot to help identify the system manufacturer

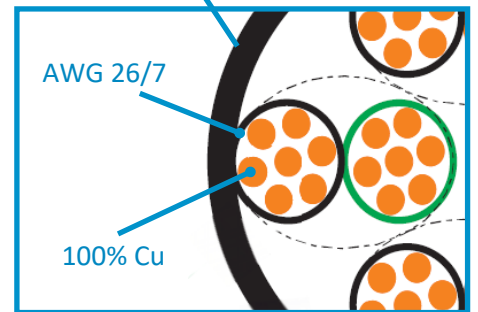

Prepared on cable with 26/7 AWG wire diameter, 100% CU

## Product Information

BKT S/FTP cat. 6<sub>A</sub> patch cord LSHF, BKT RJ45 crimped plug

Card No.: PI\_Pcord\_BKT\_RJ45\_6A\_SFTP\_LSHF\_2145N5XX.Y\_02.24

## Physical and electrical properties

Rated Voltage [V]	250
Rated Current [A]	2
Dielectric withstanding voltage	1000V AC RMS 50/60Hz
Contact resistance [mΩ]	<20
Wytrzymałość wtyku	min 200 insertion cycles
Plug body	polycarbonate
Contact blade	gold plated phosphor-bronze (50 microns)
Conector type	8P8C
Boot	PC
Boot color	transparent
Single wire diameter [AWG]	26/7
Single wire insulation	Foam Skin PE
Outer sheath	LSHF
Cable OD	5,9mm ±0,2
Shield	Al Foil, tinned copper braid
Outer sheath color	grey, green, blue, yellow, red

## Patch cord cable construction

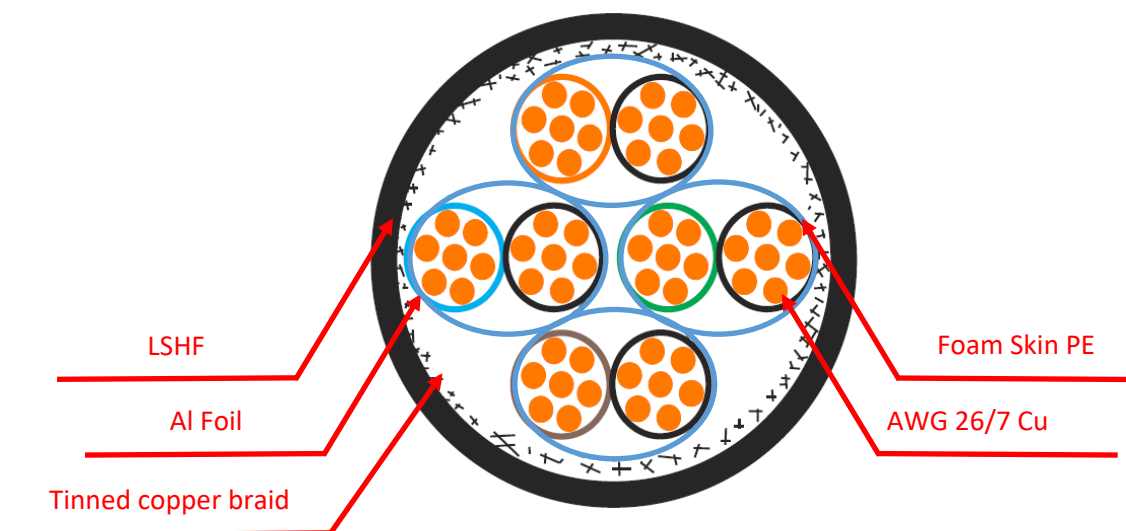

## Product Information

BKT S/FTP cat. 6<sub>A</sub> patch cord LSHF, BKT RJ45 crimped plug

Card No.: PI\_Pcord\_BKT\_RJ45\_6A\_SFTP\_LSHF\_2145N5XX.Y\_02.24

## Patch cord plug&boot dimensions [mm]

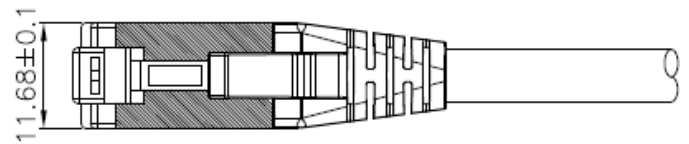
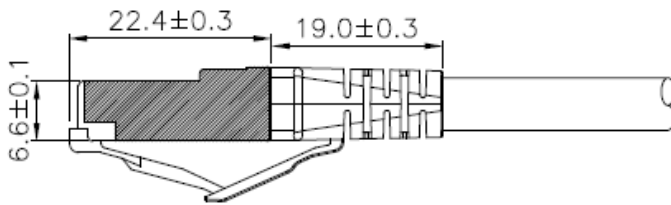

## Performance / Variants

Index	Product description
2145N5XX.Y	BKT S/FTP cat. 6 <sub>A</sub> patch cord LSHF, BKT RJ45 crimped plug

2145N5XX.Y where:

XX patch cord color: 00 - grey, 11 - green, 22 - blue, 33 - yellow, 44 - red

Y patch cord length (m): 0,5; 1; 1,5; 2; 3; 5;

Other lengths available after contact with BKT

## Optional accessories

Index	Product description
1133A132	Boot Color Clips for BKT RJ45 patch cords - grey (50pcs/bag)
1133A133	Boot Color Clips for BKT RJ45 patch cords - blue (50pcs/bag)
1133A134	Boot Color Clips for BKT RJ45 patch cords - red (50pcs/bag)
1133A135	Boot Color Clips for BKT RJ45 patch cords - yellow (50pcs/bag)
1133A136	Boot Color Clips for BKT RJ45 patch cords - black (50pcs/bag)
1133A137	Boot Color Clips for BKT RJ45 patch cords - green (50pcs/bag)
1133A138	Boot Color Clips for BKT RJ45 patch cords - orange (50pcs/bag)